



KONICA MINOLTA

CHROMA METER CR-400/410



CR-400

CR-410



The essentials of imaging

Introducing the successor to the Konica Minolta CR-300/310, our best-selling colorimeter globally accepted as the standard in a wide range of industries.

CR-400

Measurement area \varnothing 8mm

CR-410

Measurement area \varnothing 50mm



● The measuring head can perform measurement alone.

The measuring head is detachable from the data processor. Now, you can take measurements directly with the head alone. What's more, you can connect the measuring head directly to a PC. Simply install our optional software, and your PC can function as the data processor.

● User-defined evaluation formulas freely set up.

The CR-400 Series features a User Index function that allows you to configure the evaluation formula and color-calculation formula as desired. This feature is intended to meet the needs of color-control applications in which industry-specific or customized evaluation formulas are used instead of the versatile color system and standard evaluation formula such as $L^*a^*b^*$.

(Settings can be configured via a PC with optional software installed.)

Abundant accessories applicable to various materials.

A varied selection of accessories is available to accommodate various types of targets including powder, paste and opaque liquids.

● Compact data processor incorporates a high-speed printer.

The compact, lightweight data processor is battery-operated* and features a built-in high-speed printer. Its size and weight are approximately one-half those of the conventional DP-300 Series. In addition, the CR-400 Series is designed with a detachable shoulder strap for easier portability. *An AC adapter is included as a standard accessory.

Full data compatibility with the CR-300/310 series

To ensure data compatibility, the CR-400 Series utilizes the same illumination-viewing optical system as the conventional CR-300/310 Series. As a result, those upgrading from the preceding model can make full use of their existing data.

Easy-to-understand the name on the buttons, ensure smooth measurement and setting operations.

Achieves exceptional accuracy

Inter-instrument agreement : CR-400: ΔE^*ab within 0.6

CR-410: ΔE^*ab within 0.8

Repeatability : within ΔE^*ab 0.07

User calibration function ensures higher accuracy.

(Settings can be configured with the data processor or via a PC with optional software installed.)

● Color difference tolerance can be set to perform PASS/WARN/FAIL

(Settings can be configured with the data processor or via a PC with optional software installed.)

● Offers a wider range of color systems than the CR-300/310 Series.

● The measuring head alone can store up to 1,000 measurements. When the data processor is connected, up to 2,000 measurements can be stored.(The measuring head can store up to 100 color-difference target colors with or without the data processor connected.)

● Capable of displaying color-difference graphs that provide a visual representation of the color difference.

(When connected to data processor)

● A simple, cellular-phone-type text entry system is provided for entering the names of color-difference target colors and calibration channels.

(When connected to data processor)

● Features a large, easy-to-see LCD with a built-in backlight.

● The LCD offers six user-selectable languages for the display mode, including English and Japanese.

(When connected to data processor)

Can be powered with rechargeable batteries for reduced operating costs.

● Denotes a new feature not available with the previous CR-300/310 Series.

The CR-400/410 Series really shows its abilities in these applications.

When measuring powders or pastes



With the varied accessories, you can measure targets with diverse profiles.



Granular-Materials Attachment **CR-A50**



Glass Light-Projection Tube **CR-A33f** (For CR-400) **CR-A33e** (For CR-410)



When color control is performed with a customized evaluation formula, instead of the versatile color system



User-defined evaluation formulas can be entered as desired. Now, you can control color with customized evaluation formulas.

User index function
-Example-
Evaluation of tomato ripeness= $a^*/b^*+0.3a^*/L^*$

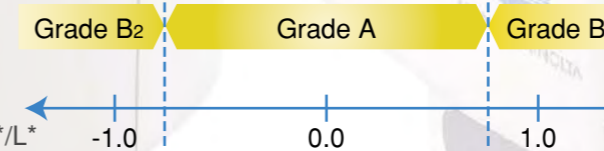

Note: The evaluation formula and grade indicated above are hypothetical examples used only to demonstrate the user index function.



When a compact colorimeter is needed in the field



The measuring head can be used independently of the data processor. This is advantageous when portability is required or limited space is available.



When measurements need to be printed on-site for labeling of samples



The compact data processor features a built-in printer for superior mobility.



System Diagram

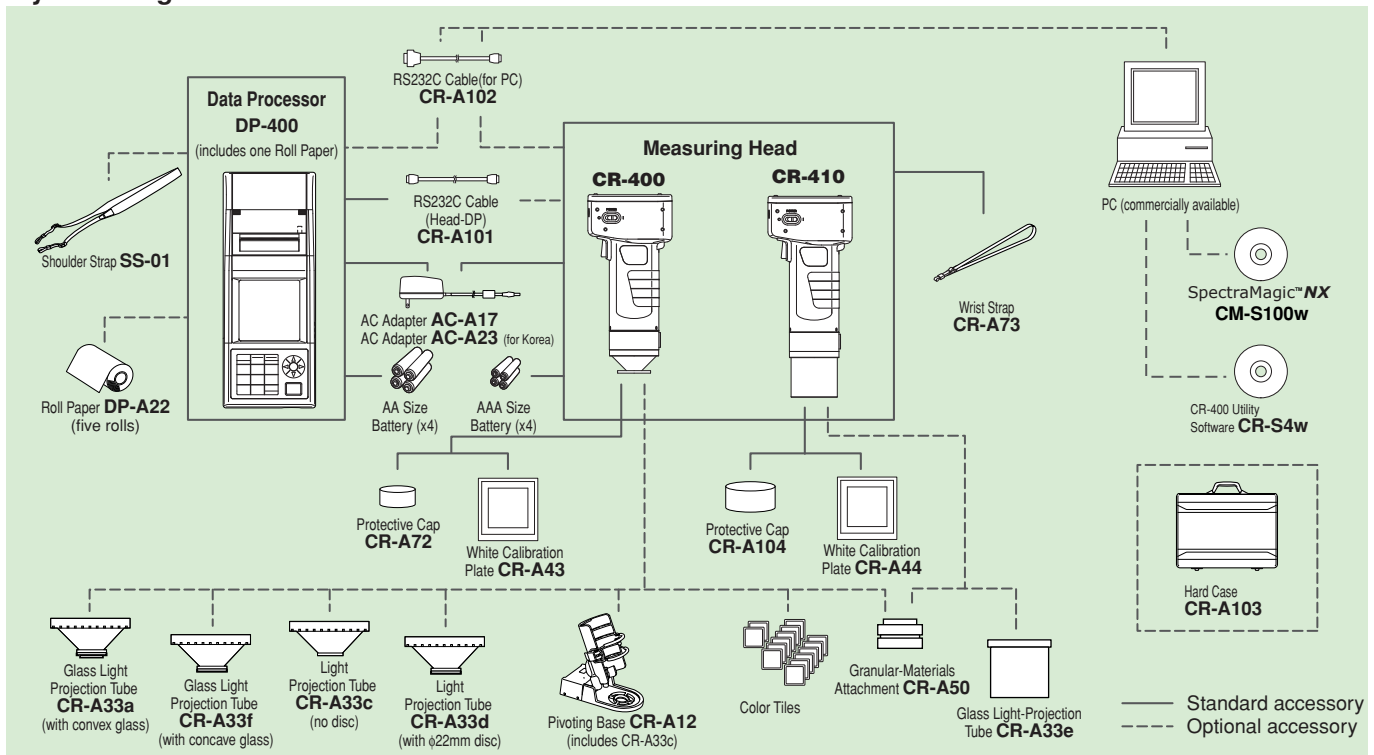

Optional Accessories



Granular-Materials Attachment **CR-A50**

With the Granular-Materials Attachment CR-A50, the color of powders, pastes, grains, and other granular substances can be easily and accurately measured.

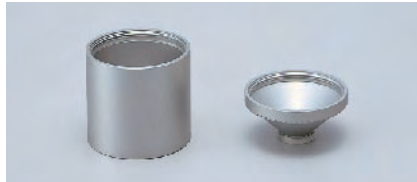

Glass Light-Projection Tube

CR-A33f (For CR-400) and **CR-A33e** (For CR-410) Glass Light-Projection Tube CR-A33f and CR-A33e have a glass plate at the tip and can be used for measuring wet surfaces or for ensuring that materials such as textiles are flat during measurements.

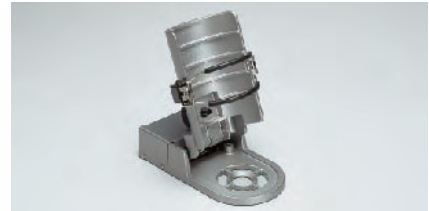

Pivoting Base **CR-A12** (For CR-400)

Attaching the Pivoting Base CR-A12 to the Measuring head of the CR-400 ensures greater stability and accuracy in measurements. Light-Projection Tube CR-A33c is also included.

SpectraMagic™ **NX** (optional)

Supports Windows® 2000/XP

SpectraMagic™ **NX** enables you to perform comprehensive color inspection and analysis of incoming raw materials, in process production, and outbound color critical goods and materials in virtually any industry. With SpectraMagic™ **NX** you can insert digital images with measured data. Measure samples in any of 8 universally accepted color spaces. Select from 15 illuminants, and up to 40 indices to determine specific color and appearance properties, such as brightness, haze, yellowness, opacity and strength. You can even configure up to 3 customized color equations. Reports range from simple Pass/Fail to trend charts, histograms, color plots, and spectral graphs. SpectraMagic™ **NX** comes with predefined templates using skin technology, or you can create your own templates. For illustrations and explanations to understanding color and color measurement technology, there is a link to Konica Minolta's well known and respected "Precise Color Communication".

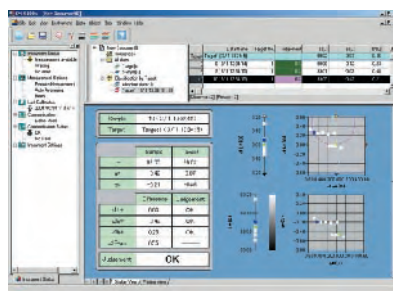

Specifications

Color space	L*a*b*, L*C*h, Lab99, LCh99, XYZ, Hunter Lab, Yxy, L*u*v*, L*u*v*, Munsell, and their color differences (excluding Munsell)
Index	WI (CIE 1982, ASTM E313-73, Hunter, Berger, Taube, Stensby, Ganz), Tint(Ganz), YI (ASTM D1925-70, ASTM E313-73, ASTM E313-96, DIN6167), WB (B ASTM E313-73), Standard Depth (ISO 105.A06), RxRyRz, Gray scale(ISO 105.A05)
Color difference equation	ΔE^*_{ab} (CIE 1976), ΔE^*_{94} (CIE 1994), ΔE_{00} (CIE 2000), ΔE_{99} (DIN99), ΔE (Hunter), CMC (1:c), FMC-2, NBS 100, NBS 200
Observer	2 degree
Illuminants	C, D65
Graph display	L*a*b* absolute value, $\Delta L^*a^*b^*$ (color difference distribution), Hunter Lab absolute value, Hunter ΔLab (color difference distribution), Trend chart and histogram of each color space and color difference equation, Pseudo Color display

CR-400 Utility Software **CR-S4w**

- To take measurements or change the measurement parameters of the CR-400/410 Series, you can control the unit with a PC.
- Measurement data can be transferred directly to a Microsoft Excel® file by means of the OLE function. (Excel® 97/2000/2002 is required to use the Excel® transfer function.)
- Calibration data and color-difference reference color data can be uploaded or modified.

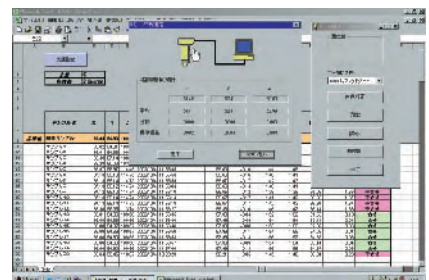

System requirements

OS	Windows® 98/2000/XP
CPU	Pentium® 166MHz or higher
Memory	32MB or higher
Hard disk	100MB or more free space
Display resolution	VGA (640x480) or higher

System requirements

OS	Windows® 2000 Professional SP4, Windows® XP Professional SP2
CPU	Pentium® III 600 MHz or higher
Memory	128 MB (256 MB recommended)
Hard disk	450 MB of available disk space
Display	Graphic card capable of displaying 1024 x 768/High Color (16-bit)
Other	CD-ROM drive (required for installation) One free USB port or printer port (for protection key) One free serial port (for instrument) Internet Explorer Ver. 5.01 or later

Specifications

Name	Chroma Meter Measuring Head	
Model	CR-400 Head	CR-410Head
Illuminating/viewing system	d/0 (Diffuse illumination/0° viewing angle) (Specular component included)	Wide-area illumination/0° viewing angle (Specular component included)
Detector	Silicone photo cells (6)	
Display range	Y: 0.01 to 160.00% (reflectance)	
Light source	Pulsed xenon lamp	
Measurement time	1 seconds.	
Minimum measurement interval	3 seconds.	
Battery performance	Approx. 800 measurements (when using batteries under company testing Konica Minolta's conditions)	
Measurement/illumination area	ø8/ø11	ø50/ø53
Repeatability	Within ΔE*ab,0.07 standard deviation (when the white calibration plate is measured 30 times at intervals of 10 seconds)	
Inter instrument agreement	ΔE*ab: within 0.6	ΔE*ab: within 0.8
Observer	Average of 12 BCRA series II colors	
Illuminant *1	2 degrees Closely matches CIE 1931 Standard Observers: ($\bar{x}_2\lambda$, $\bar{y}_2\lambda$, $\bar{z}_2\lambda$) C, D ₆₅	
Display *1	Chroma values, color difference values, PASS/WARN/FAIL display	
Tolerance judgment *1	Color difference tolerance (box tolerance and elliptical tolerance)	
Color space/ colorimetric data	XYZ, Y x y, L*a*b*, Hunter Lab, L*C*h, Munsell (only illuminant C), CMC(l:c), CIE1994, Lab99, LCh99, CIE2000, CIE WI-Tw (only illuminant D ₆₅), WI ASTM E313 (only illuminant C), YI ASTM D1925 (only illuminant C), YI ASTM E313 (only illuminant C), User index (up to six can be registered from computer)	
Languages	Operating keys : English LCD : English (default) (LCD : German, French, Italian, Spanish, Japanese) *1	
Storable data sets	1000 (measuring head and data processor save different data)	
Color difference target colors	100	
Calibration channels *1	20 channels (ch00 : white calibration, ch01 to ch19 : user calibration)	
Display	Dot-matrix LCD with back light (15 chars x 9 lines + 1 line for icon display)	
Interface	RS-232C compliant (for data processor/PC) * Baud rate : 4800, 9600, 19200 (bps), set at 9600 bps when shipped from factory	
Power source	4 AAA size alkaline or Ni-MH batteries, AC adapter (AC-A17) AC120V ~ 50-60Hz 0.4A (for N.America and Japan) AC230V ~ 50-60Hz 0.4A (for worldwide except N.America)	
Size	102(W) x 217(H) x 63(D)mm	102(W) x 244(H) x 63(D)mm
Weight	Approx. 550g (including 4 AAA size batteries and not including RS-232C cable)	Approx. 570g
Operating temperature/humidity range	0 to 40°C, relative humidity 85% or less (at 35°C) with no condensation * Operating temperature/humidity range of products for North America : 5 to 40°C, relative humidity 80% or less (at 31°C) with no condensation	
Storage temperature/humidity range	-20 to 40°C, relative humidity 85% or less (at 35°C) with no condensation	
Other	LCD back light ON/OFF function (when ON, back light stays ON for 30 seconds after last key or measurement operation)	

*1 indicates when connected to the Data Processor or when not set using the Data Processor or the optional software, that some of the function are not available when the measuring head is not connected.

Name	Data Processor	
Model	DP-400	
Display range	Y : 0.01 to 160.00% (reflectance)	
Measurement time *2	1 Seconds.	
Minimum measurement interval *2	3 Seconds.	
Battery performance	Approx. 800 measurements (when using batteries under company testing Konica Minolta's conditions)	
Illuminants	C, D ₆₅	
Display	Chroma values, color difference values, color difference graphs, PASS/WARN/FAIL display	
Tolerance judgment *2	Color difference tolerance (box tolerance and elliptical tolerance) Only for the display function	
Color space/ colorimetric data	XYZ, Y x y, L*a*b*, Hunter Lab, L*C*h, Munsell (only illuminant C), CMC (l:c), CIE1994, Lab99, LCh99, CIE2000, CIE WI-Tw (only illuminant D ₆₅), WI ASTM E313 (only illuminant C), YI ASTM D1925 (only illuminant C), YI ASTM E313 (only illuminant C), User index (up to six registered in the Measuring Head can be used)	
Languages	Operating keys : English, LCD : English (default), German, French, Italian, Spanish, Japanese	
Storable data sets	Max. 2000 pieces of data (divisible into 100 pages) Deletion and Undoing selected stored data (one piece of data or all data) are possible	
Color difference target colors *2	Only for the operating function (100 pieces of data when the measuring head is connected; input of measurement values or numeric) (independent of page function)	
Calibration channels *2	Only for the operating function (20 channels when the measuring head is connected) (ch00: white calibration; ch01 to ch19: user calibration)	
Page function	100 pages	
Display	Dot-matrix LCD with back light (16 chars x 9 lines + 1 line for icon display) Contrast adjustment	
Printer	384 dot line thermal printer (can also print graphs) Automatically prints out all measurement results (can be set not to print)	
Statistical function	Maximum, minimum, average, and standard deviation	
Automatic measurement *2	Date and time display: year, month, day, hour, minute Timer: 3seconds. to 99 minutes. (Some measurement modes require more than 3 seconds.)	
Interface	RS-232C compliant Baud rate (bps) : 19200 fixed (when connected to PC) When measuring head is connected baud rate is automatically set to that of the measurement head	
Power source	4 AA size alkaline or Ni-MH batteries, AC adapter (AC-A17) AC120V ~ 50-60Hz 0.4A (for N.America and Japan) AC230V ~ 50-60Hz 0.4A (for worldwide except N.America)	
Size	100(W) x 73(H) x 255(D)mm	
Weight	Approx. 600g (not including batteries and paper)	
Operating temperature/humidity range	0 to 40°C, relative humidity 85% or less (at 35°C) with no condensation * Operating temperature/humidity range of products for North America : 5 to 40°C, relative humidity 80% or less (at 31°C) with no condensation	
Storage temperature/humidity range	-20 to 40°C, relative humidity 85% or less (at 35°C) with no condensation	
Other	User calibration function (multi-calibration/manual calibration) *2, Measurements for automatic average function, Print ON/OFF function, CR-400 measurement data import function *2, All color space print ON/OFF function, Data protection ON/OFF function, Back light ON/OFF function, Buzzer ON/OFF function, Display color limit function, Remote mode (stored data output), Character input function (alphanumeric)	

*2 indicates that part of or all functions are not available when the measurement head is not connected.

Dimensions

Units : mm

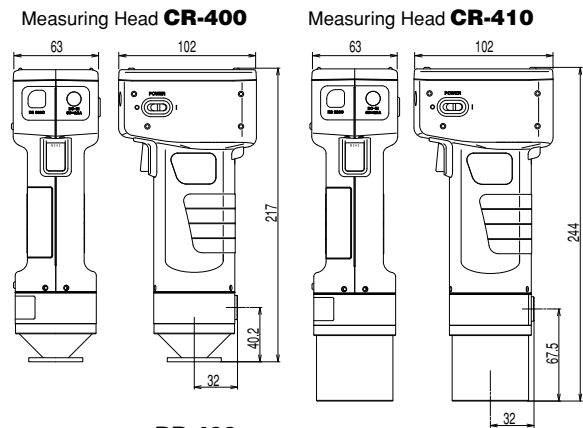

Data Processor DP-400

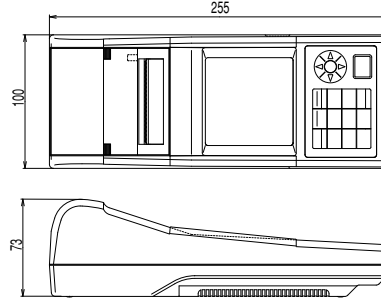

Standard/Optional accessories

	Measuring Head CR-400	Measuring Head CR-410	Data Processor DP-400
Color Data Software CM-S100w	○	○	○
SpectraMagic™ NX	○	○	○
CR-400 Utility Software	○	○	○
CR-S4w	○	○	○
White Calibration Plate CR-A43	●	○	○
White Calibration Plate CR-A44	○	●	○
Protective Cap CR-A72	●	○	○
Protective Cap CR-A104	○	●	○
RS-232C Cable CR-A101 (Head-DP)	○	○	●
RS-232C Cable CR-A102 (for PC)	○	○	○
AC Adapter AC-A17	○	○	○
AC Adapter AC-A23 (for Korea)	○	○	○
Wrist Strap CR-A73	○	○	○
Shoulder Strap SS-01	○	○	○
Hard Case CR-A103	○	○	○
Roll Paper (one roll)	○	○	○
Roll Paper DP-A22 (five rolls)	○	○	○
4 AA Size Batteries	○	○	○
4 AAA Size Batteries	○	○	○
Glass Light-Projection Tube CR-A33a/f	○	○	○
Light-Projection Tube CR-A33c/d	○	○	○
Glass Light-Projection Tube CR-A33e	○	○	○
Granular-Materials Attachment CR-A50	○	○	○
Pivoting Base CR-A12	○	○	○
Color Tiles	○	○	○

● Standard accessory
○ Optional accessory

Specifications are subject to change without notice.



SAFETY PRECAUTIONS

For correct use and for your safety, be sure to read the instruction manual before using the instrument.

- Always connect the instrument to the specified power supply voltage. Improper connection may cause a fire or electric shock.
- Be sure to use the specified batteries. Using improper batteries may cause a fire or electric shock.

KONICA MINOLTA SENSING, INC.
Konica Minolta Sensing Americas, Inc
Konica Minolta Sensing Europe B.V.

Osaka, Japan
New Jersey, U.S.A.
European Headquarter /BENELUX
German Office (International)
German Office (Germany)
French Office
UK Office
Italian Office
Swiss Office
Nordic Office
Austrian Office
Polish Office

Phone : 888-473-2656(in USA), 201-236-4300(outside USA)
Nieuwegein, Netherland
Langenhagen, Germany
München, Germany
Roissy CDG, France
Milton Keynes, United Kingdom
Milan, Italy
Dietikon, Switzerland
Västra Frölunda, Sweden
Wien, Austria
Warszawa, Poland
Shanghai, China
Beijing, China
Guangzhou, China
Singapore
Seoul, Korea

Fax : 201-785-2480
Fax : +31(0)30 248-1211
Fax : +49(0)511 7404-807
Fax : +49(0)89 630267-67
Fax : +33(0)1 493-82519
Fax : +44(0)1908 540-629
Fax : +39(0)23 9011219
Fax : +41(0)43 322-9809
Fax : +46(0)31 474945
Fax : +43(0)1 87882-431
Fax : +48(0)22 56033-01
Fax : +86-021-5489 0202
Fax : +86-010-8522 1551
Fax : +86-020-3826 4220
Fax : +65 6563-5533
Fax : 02-523-9726

Konica Minolta (CHINA) Investment Ltd.
SE Sales Division
SE Beijing Office
SE Guangzhou Office

Konica Minolta Sensing Singapore Pte Ltd.
KONICA MINOLTA SENSING, INC. Seoul Office

Addresses and telephone/fax numbers are subject to change without notice. For the latest contact information, please refer to the KONICA MINOLTA SENSING Worldwide Offices web page (link below).

©2002 KONICA MINOLTA SENSING, INC.

<http://konicaminolta.com/about/se/contact.html>

9242-4889-11 AGMGPK® Printed in Japan